



Smart Managed Switch

Quick Start Guide



- About this Document**
- This Document includes instructions for using and managing the Product, charts, images, and all other information hereinafter are for description and explanation only.
 - The information contained in the Document is subject to change, without notice, due to firmware updates or other reasons. Please find the latest version of the Document at the Hikvision website (<https://www.hikvision.com>). Unless otherwise agreed, Hangzhou Hikvision Digital Technology Co., Ltd. or its affiliates (hereinafter referred to as "Hikvision") makes no warranties, express or implied.
 - Please use the Document with the guidance and assistance of professionals trained in supporting the Product.

About this Product

This product can only enjoy the after-sales service support in the country or region where the purchase is made.

Acknowledgment of Intellectual Property Rights

- Hikvision owns the copyrights and/or patents related to the technology embodied in the Products described in this Document, which may include licenses obtained from third parties.
- Any part of the Document, including text, pictures, graphics, etc., belongs to Hikvision. No part of this Document may be excerpted, copied, translated, or modified in whole or in part by any means without written permission.
- HIKVISION and other Hikvision's trademarks and logos are the properties of Hikvision in various jurisdictions.
- Other trademarks and logos mentioned are the properties of their respective owners.

LEGAL DISCLAIMER

- TO THE MAXIMUM EXTENT PERMITTED BY APPLICABLE LAW, THIS DOCUMENT AND THE PRODUCT DESCRIBED, WITH ITS HARDWARE, SOFTWARE AND FIRMWARE, ARE PROVIDED "AS IS" AND "WITH ALL FAULTS AND ERRORS". HIKVISION MAKES NO WARRANTIES, EXPRESS OR IMPLIED, INCLUDING WITHOUT LIMITATION, MERCHANTABILITY, SATISFACTORY QUALITY, OR FITNESS FOR A PARTICULAR PURPOSE. THE USE OF THE PRODUCT BY YOU IS AT YOUR OWN RISK. IN NO EVENT WILL HIKVISION BE LIABLE TO YOU FOR ANY SPECIAL, CONSEQUENTIAL, INCIDENTAL, OR INDIRECT DAMAGES, INCLUDING, AMONG OTHERS, DAMAGES FOR LOSS OF BUSINESS PROFITS, BUSINESS INTERRUPTION, OR LOSS OF DATA, CORRUPTION OF SYSTEMS, OR LOSS OF DOCUMENTATION, WHETHER BASED ON BREACH OF CONTRACT, TORT (INCLUDING NEGLIGENCE), PRODUCT LIABILITY, OR OTHERWISE, IN CONNECTION WITH THE USE OF THE PRODUCT, EVEN IF HIKVISION HAS BEEN ADVISED OF THE POSSIBILITY OF SUCH DAMAGES OR LOSS.
- YOU ACKNOWLEDGE THAT THE NATURE OF THE INTERNET PROVIDES FOR INHERENT SECURITY RISKS, AND HIKVISION SHALL NOT TAKE ANY RESPONSIBILITIES FOR ABNORMAL OPERATION, PRIVACY LEAKAGE OR OTHER DAMAGES RESULTING FROM CYBER-ATTACK, HACKER ATTACK, VIRUS INFECTION, OR OTHER INTERNET SECURITY RISKS; HOWEVER, HIKVISION WILL PROVIDE TIMELY TECHNICAL SUPPORT IF REQUIRED.
- YOU AGREE TO USE THIS PRODUCT IN COMPLIANCE WITH ALL APPLICABLE LAWS, AND YOU ARE SOLELY RESPONSIBLE FOR ENSURING THAT YOUR USE CONFORMS TO THE APPLICABLE LAW. ESPECIALLY, YOU ARE RESPONSIBLE FOR USING THIS PRODUCT IN A MANNER THAT DOES NOT INFRINGE ON THE RIGHTS OF THIRD PARTIES, INCLUDING WITHOUT LIMITATION, RIGHTS OF PUBLICITY, INTELLECTUAL PROPERTY RIGHTS, OR DATA PROTECTION AND OTHER PRIVACY RIGHTS. YOU SHALL NOT USE THIS PRODUCT FOR ANY PROHIBITED END-USES, INCLUDING THE DEVELOPMENT OR PRODUCTION OF WEAPONS OF MASS DESTRUCTION, THE DEVELOPMENT OR PRODUCTION OF CHEMICAL OR BIOLOGICAL WEAPONS, ANY ACTIVITIES IN THE CONTEXT RELATED TO ANY NUCLEAR EXPLOSIVE OR UNSAFE NUCLEAR FUEL CYCLE, OR IN SUPPORT OF HUMAN RIGHTS ABUSES.
- IN THE EVENT OF ANY CONFLICTS BETWEEN THIS DOCUMENT AND THE APPLICABLE LAW, THE LATTER PREVAILS.

© Hangzhou Hikvision Digital Technology Co., Ltd. All rights reserved.

- Place the switch against the rack so that the holes on the L-shaped brackets are aligned with the holes where the nuts have been fixed.
- Fix the brackets to the front side of the rack with two self-prepared M5 or M6 screws on both sides respectively to stably install your device.

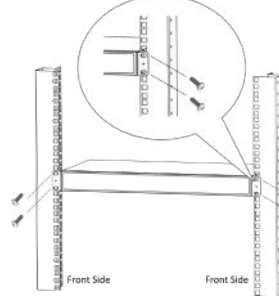

3 Ground Your Switch

Grounding is used to quickly release overvoltage and overcurrent induced by lightning for the switch, and to protect personal safety. Select an appropriate grounding method according to your needs.

Symbol Conventions

The symbols that may be found in this document are defined as follows.

Symbol	Description
	Provides additional information to emphasize or supplement important points of the main text.
	Indicates a potentially hazardous situation, which if not avoided, could result in equipment damage, data loss, performance degradation, or unexpected results.
	Indicates a hazard with a high level of risk, which if not avoided, will result in death or serious injury.

1 Learn About Your Switch

▷ Front Panel (Example)

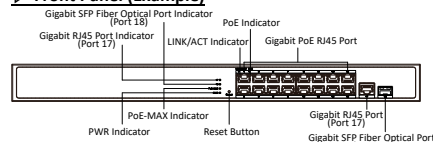

▷ Rear Panel (Example)

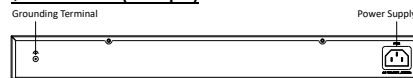

- Device appearances vary with models. The figures above are for your reference only. The actual device prevails.
- Scan the QR code to obtain product introduction, packing list, and appearance of the desired device model.

▷ With Grounding Bar

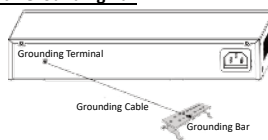

Steps

- Connect one end of the grounding cable to the binding post on the grounding bar.
- Connect the other end of the grounding cable to the device's grounding terminal and fix the screw.

▷ Without Grounding Bar

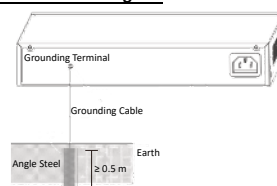

Steps

- Bury an angle steel or steel pipe (≥ 0.5 m) into the mud land.
- Weld one end of the grounding cable to the angle steel or steel pipe and embalm the welding point via electroplating or coating.
- Connect the other end of the grounding cable to the device's grounding terminal.

2 Install Your Switch

Please select an appropriate installation method according to the actual needs. The following figures are for reference only.

Before You Start

- Ensure that the desktop, wall, or rack is stable and firm enough.
- Keep the room well-ventilated. Leave at least 10 cm heat dissipation space around the device.
- Keep at least 1.5 cm vertical distance between two adjacent devices for rack mounting.

▷ Desktop Placement

Place the device on the desk.

▷ Wall Mounting

Steps

- Check the distance between the two hanging holes at the bottom of the device.
- Insert two self-prepared M4 screws into the wall.
- Align the hanging holes with screws, and hang the device on the screws.

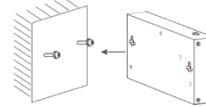

- The load-bearing capacity of the wall should be three times more than the weight of the device.
- Ensure that the distance between the two screws equals to the distance between the two hanging holes.
- Set aside at least 4 mm of the screw bodies outside the wall.

▷ Rack Mounting

Steps

- Check the grounding and stability of the rack.
- Use M3 screws provided in the package to fix the two L-shaped brackets to both sides of the device.

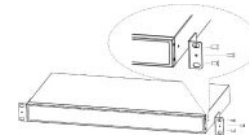

The number of screws provided for fixing L-shaped brackets to the device varies with device models.

- Fix two self-prepared M5 or M6 nuts to the rear side of the rack on both sides respectively.

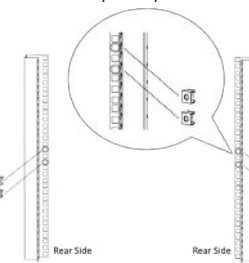

4 Connect Your Switch to a Peer Device

▷ RJ45 Port

Use a network cable to connect the device to the RJ45 port of a peer device such as the IP camera (IPC), NVR, switch, etc.

▷ SFP Fiber Optical Port

If the device has a fiber optical port or a combo, connect the device to a peer device through an optical fiber connecting optical modules plugged into fiber optical ports respectively.

- When connected to a network cable, the combo is a RJ45 port.
- When plugged into with an optical module and connected to an optical fiber, the combo functions as a fiber optical port.
- When connected to both the network cable and optical fiber at the same time, the combo works as a fiber optical port.

Steps

- Connect the two paired SFP optical modules with an optical fiber.
- Hold the SFP optical module from one side, and smoothly plug it into the switch along with the SFP port slot until the optical module and the switch are closely attached.
- After powering your switch on, check the status of the LINK/ACT indicator.
 - If the indicator is lit, the link is connected.
 - If the indicator is unlit, the link is disconnected. Check the line, and make sure the peer device has been started.



- Single-mode optical modules need to be paired.
- Do not bend an optical fiber (curvature radius ≥ 10 cm) overly.
- Do not look directly at an optical fiber connector as laser is harmful to eyes.

5 Power Your Switch On

Please use the attached power cord (and power adapter, if any) in package to power on the device.

Before powering your switch on, make sure that:

- The operating power supply is compliant with the rated input standard.
- Port cables and grounding cables are correctly connected.
- If there is outdoor cabling, connect a lightning rod and lightning arrester to the cable.



Power cables and network cables cannot be wired together, otherwise the PD or switch ports will be burnt.

6 Manage Your Switch on Hik-Partner Pro

You can batch activate Hikvision devices such as switches, NVRs, and IPCs, and add the devices to a site for device management on the Hik-Partner Pro app.

Before You Start

- Install the Hik-Partner Pro app.
- Power on the devices and connect them to the network.
- Connect your phone to a Wi-Fi network. If you cannot connect to a Wi-Fi network, use a USB-C RJ45 adapter to connect your phone to a LAN.
- Make sure your phone and the devices in your networking (such as the switch, NVR, and IPCs) are on the same LAN and are not activated.



The following network topology is for your reference only. You can connect your devices according to your actual networking requirements.

◆ Network Topology (Example)

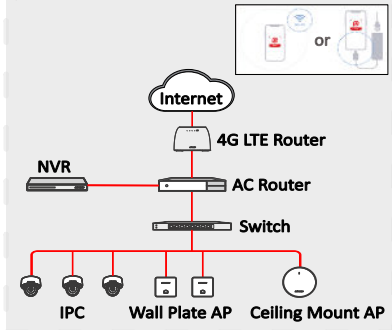

◆ Hik-Partner Pro Download



Note

- The user manual of Hik-Partner Pro is available for your reference on the app.
- The following operations may vary with app versions.

9

Step 1 Batch Activate Devices

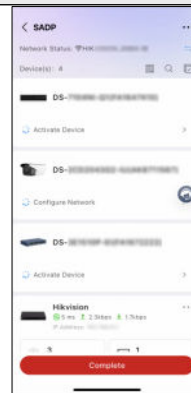
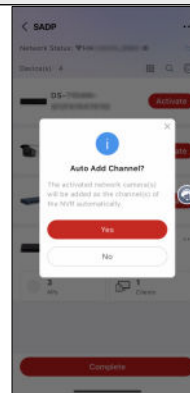
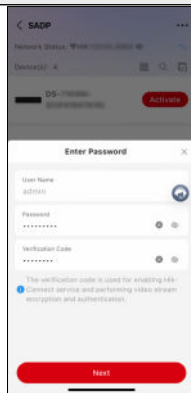
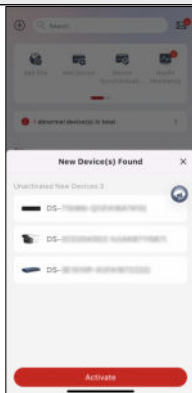

- Open the Hik-Partner Pro app, and tap **Activate** to batch activate new devices found. The app automatically searches for and displays inactivated new devices on the same LAN.

- Enter the password for user **admin** and verification code, and tap **Next**.
Password: at least 8 characters, including 3 or more combinations of uppercase letters, lowercase letters, digits, and special characters; cannot contain user name or the reverse, '123', or 'admin' (case-insensitive), 4 or more consecutively increasing or decreasing digits (such as '1234' and '4321'), or 4 or more identical characters (such as '1111' and 'aaaa'); cannot be a common risky password.
Verification Code: 6 to 12 characters, including uppercase letters, lowercase letters, and digits.

- Optional:** Tap **Yes** to add the activated IPC(s) as the channel(s) of the NVR automatically.
Note
 If you tap **No**, you need to manually add channels to the NVR after activation is complete.

- Wait until the devices are activated and the IPC(s) is/are added as channel(s) of the NVR, and then tap **Complete**.

10

11

12

13

Step 2 Add Devices to Site

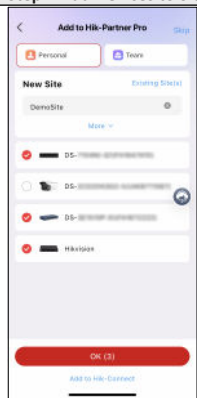

- Optional:** Create a new personal or team site, or select an existing site.
- Select the NVR, switch, and AC router, and tap **OK** to add the devices to the site.

14

Step 3 Deliver Site to Customer

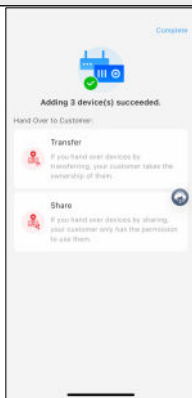

- Tap **Transfer** or **Share** to hand over the site to the customer.

Note

- If you hand over devices by **transferring**, your customer takes the ownership of them.
- If you hand over devices by **sharing**, your customer only has the permission to use them.

- Optional:** Select the desired site to view the network topology of devices added.

15

⑦ Get More Information

Scan the QR codes below to watch the HPP operation video, obtain the web and client user manuals of the device, or to quickly get support on answers to FAQs.



HPP Operation Video



Web and Client User Manuals



FAQs

16

17